

CORE_LV TM

Title Page	Sheet 1
GT64120 busses & EPLD	Sheet 2
GT64120 SDRAM & CBUS	Sheet 3
Atlas & LA connectors	Sheet 4
MIPS LV & clocking	Sheet 5
Power supplies	Sheet 6
CPU Debug & bond-out	Sheet 7

Copyright (c) 2000 MIPS Technologies, Inc. All Rights Reserved.		Government Use Restricted. Use Subject to License.	
MIPS TECHNOLOGIES			
DRG_NAME: CORE_LV		REV: 02.00	
DRG_NUM: MD00023		REV: 02.00	
SHEET_TITLE: Contents			
SHEET REV: \$Revision: 1.7 \$	ENG: DAN THOMAS	SIZE	
SDate: 2000/05/04 14:59:44 \$	SHEET 1 of 7	D	

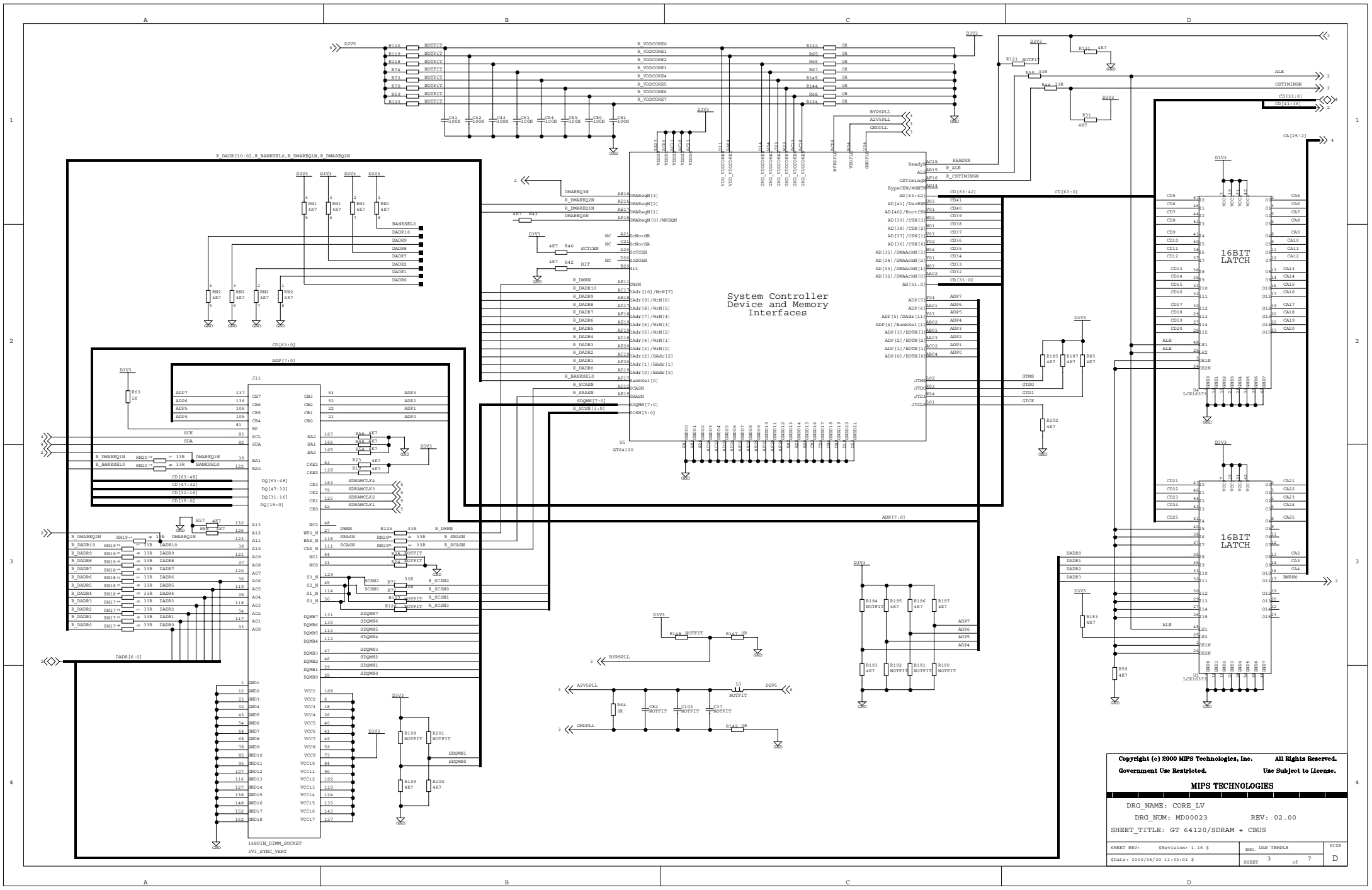

Copyright (c) 2000 MIPS Technologies, Inc. All Rights Reserved.
 Government Use Restricted. Use Subject to License.

MIPS TECHNOLOGIES

DRG_NAME: CORE_LV	REV: 02.00
DRG_NUM: MD00023	
SHEET_TITLE: GT 64120/SDRAM + CBUS	
SHEET REV: \$Revision: 1.16 \$	ENG: DAN THOMAS
SDate: 2000/06/20 11:33:01 \$	SHEET 3 of 7

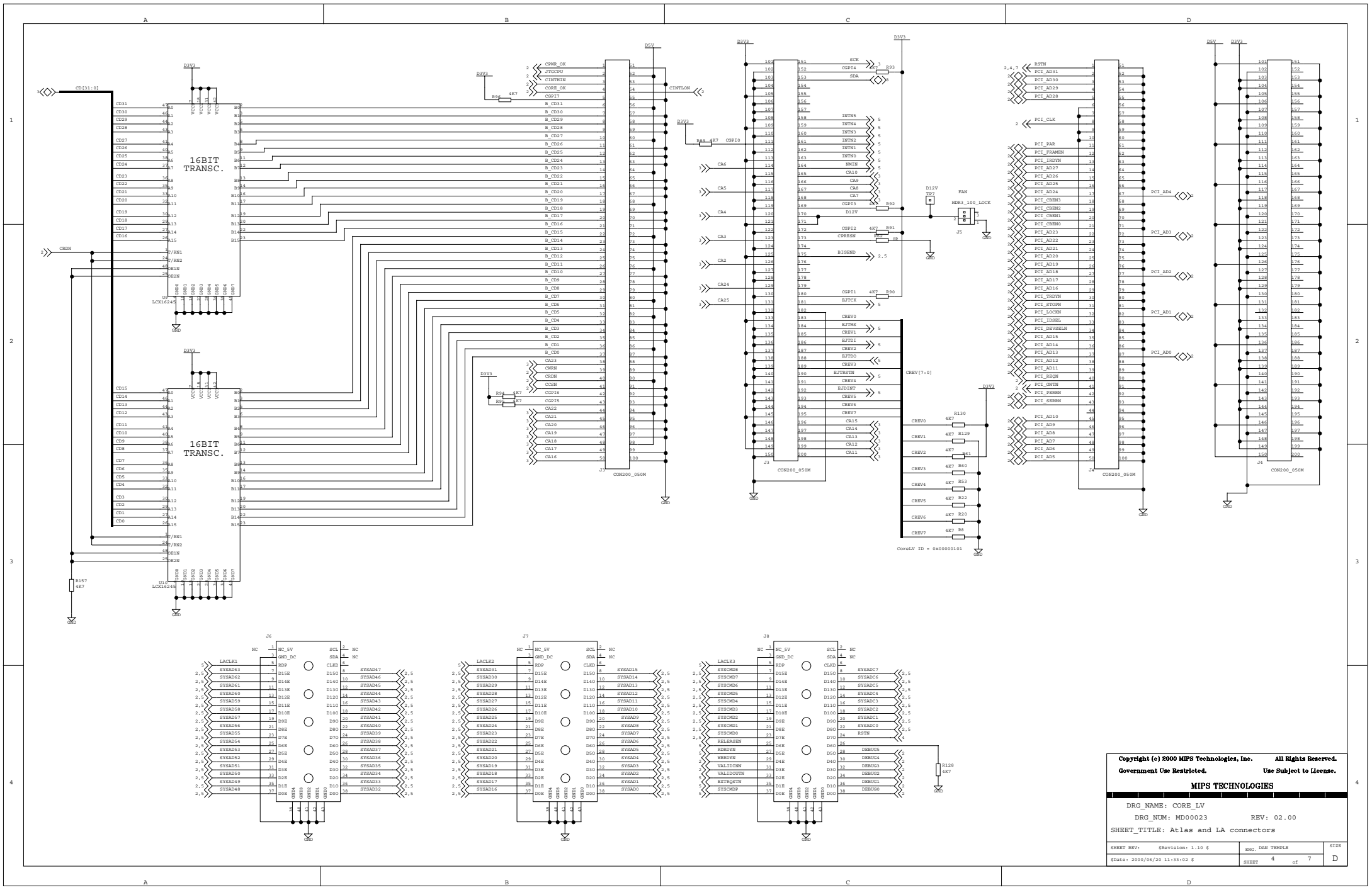

Copyright (c) 2000 MIPS Technologies, Inc. All Rights Reserved.
 Government Use Restricted. Use Subject to License.

MIPS TECHNOLOGIES

DRG_NAME: CORE_LV	
DRG_NUM: MD00023	REV: 02.00
SHEET_TITLE: Atlas and LA connectors	
SHEET REV: \$Revision: 1.10 \$	ENG: DAN THOMPSON
SDate: 2000/06/20 11:33:02 \$	SHEET 4 of 7

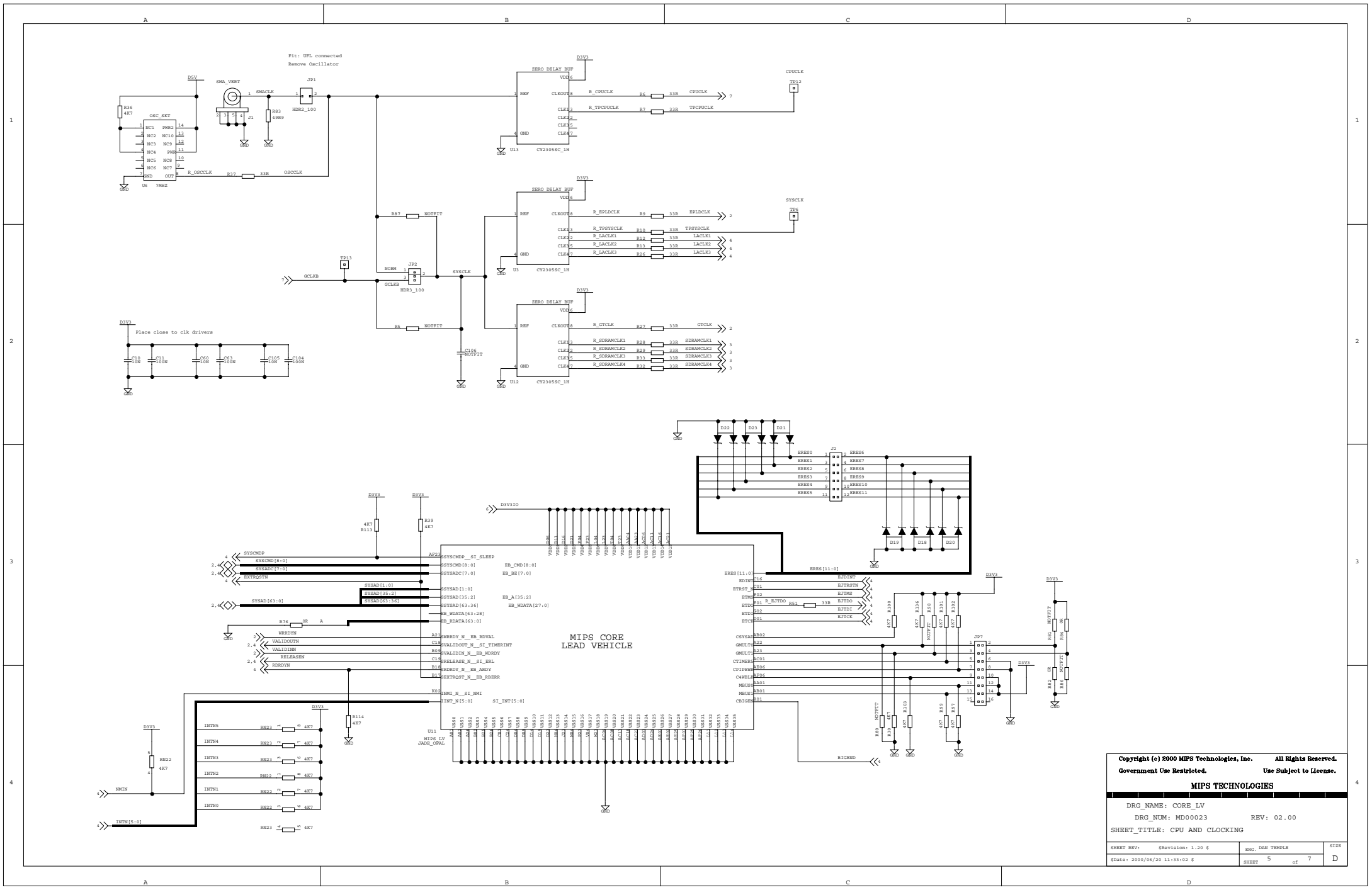

Copyright (c) 2000 MIPS Technologies, Inc. All Rights Reserved.
 Government Use Restricted. Use Subject to License.

MIPS TECHNOLOGIES

DRG_NAME: CORE_LV
 DRG_NUM: MD00023 REV: 02.00

SHEET_TITLE: CPU AND CLOCKING

SHEET REV: \$Revision: 1.20 \$ ENG: DAN THOMAS SIZE
 \$Date: 2000/06/20 11:33:02 \$ SHEET 5 of 7 D

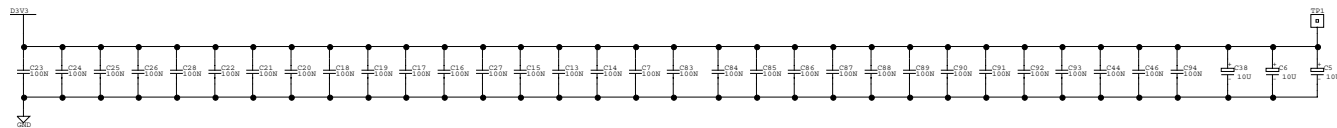
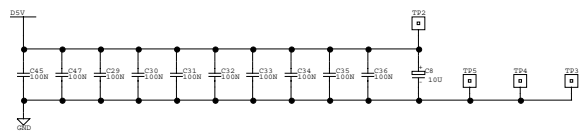
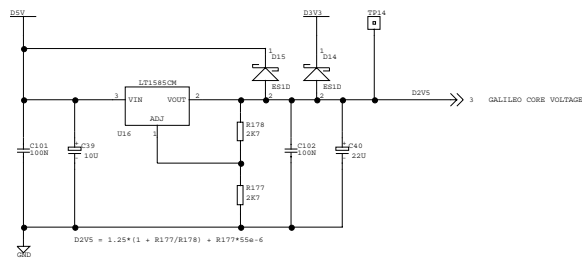
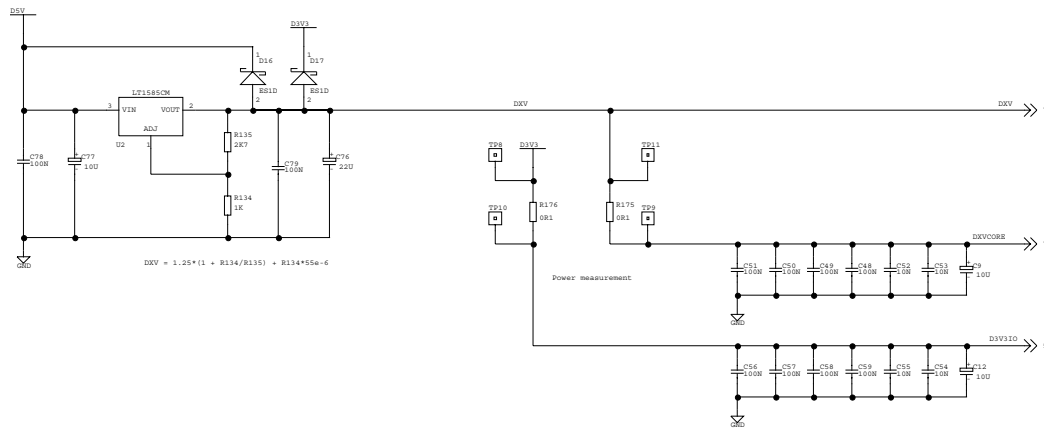

Copyright (c) 2000 MIPS Technologies, Inc. All Rights Reserved.
 Government Use Restricted. Use Subject to License.

MIPS TECHNOLOGIES

DRG_NAME: CORE_LV		REV: 02.00	
DRG_NUM: MD00023		REV: 02.00	
SHEET_TITLE: POWER			
SHEET REV:	Revision: 1.11.5	ENG: DAN THOMAS	SIZE: D
SDate: 2000/06/15 16:30:20		SHEET: 6 of 7	

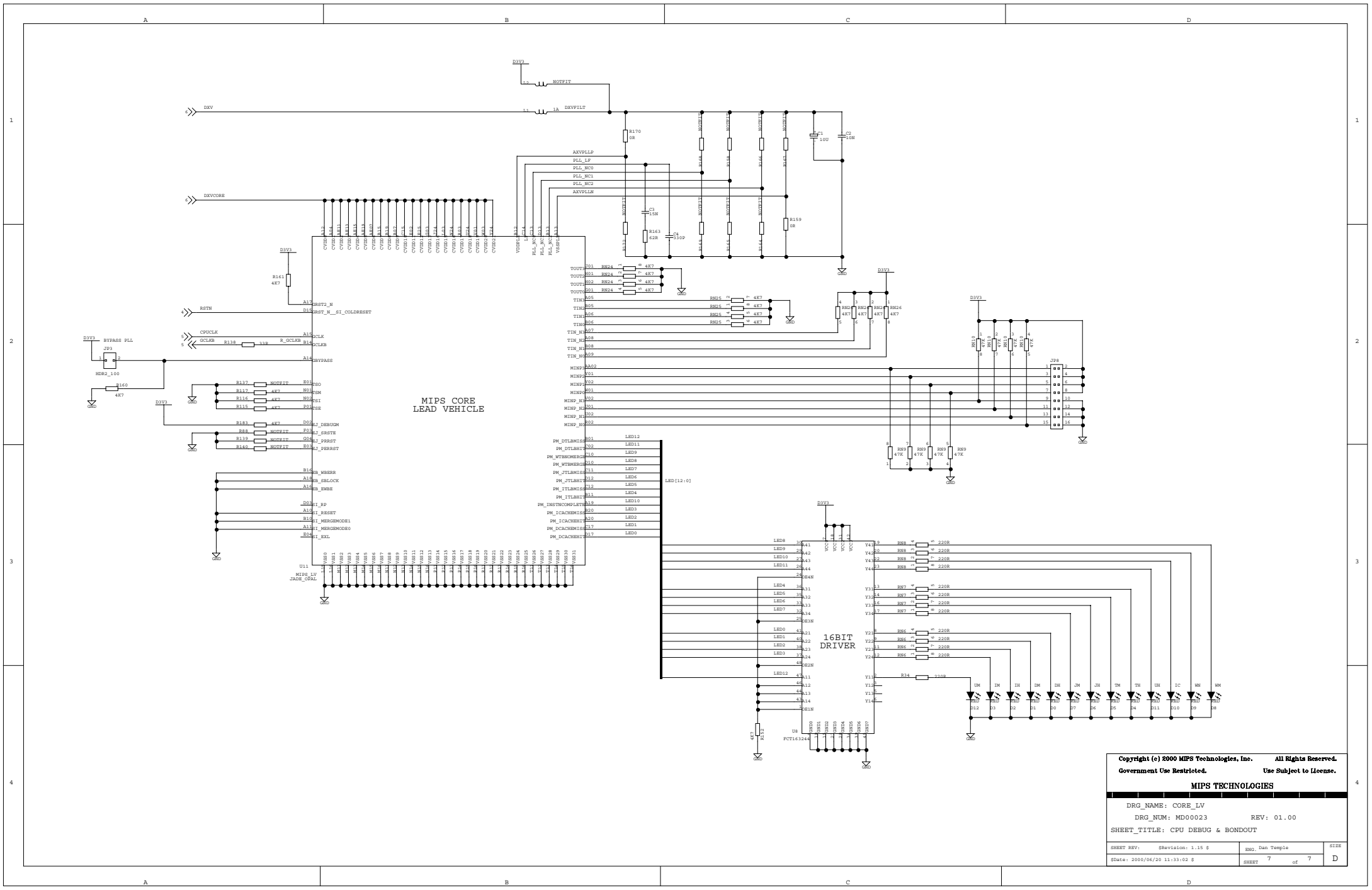

Copyright (c) 2000 MIPS Technologies, Inc. All Rights Reserved.
 Government Use Restricted. Use Subject to License.

MIPS TECHNOLOGIES

DRG_NAME: CORE_LV
 DRG_NUM: MD00023 REV: 01.00

SHEET_TITLE: CPU DEBUG & BONDOUT

SHEET REV: \$Revision: 1.15 \$	ENG: Dan Temple	SIZE
\$Date: 2000/06/20 11:33:02 \$	SHEET 7 of 7	D